



LESSON PLANS

TO TRAIN
LIKE YOU FLY

A FLIGHT
INSTRUCTOR'S
REFERENCE FOR
SCENARIO-BASED
TRAINING

Second Edition

Arlynn McMahon

LESSON PLANS

TO TRAIN
LIKE YOU FLY

A FLIGHT
INSTRUCTOR'S
REFERENCE FOR
SCENARIO-BASED
TRAINING

Second Edition

Arlynn McMahon



Aviation Supplies & Academics, Inc.
Newcastle, Washington

Lesson Plans to Train Like You Fly: A flight instructor's reference for scenario-based training

Second Edition

by Arlynn McMahon

© 2016 Aviation Supplies & Academics, Inc. All rights reserved.

The purpose of this book is to provide information on aviation training. The user of this information assumes all risk and liability arising from such use. Neither the publisher nor the author can take responsibility for the actual operation of an aircraft or the safety of its occupants.

Aviation Supplies & Academics, Inc.

7005 132nd Place SE • Newcastle, WA 98059

Website: www.asa2fly.com • Email: asa@asa2fly.com

Visit the ASA website (www.asa2fly.com) for updates posted for this book.

See also www.asa2fly.com/reader/lessonplans, the "Reader Resources" webpage with additional material for free download.

Photo credits: Cover (front), © Sean Justice/Corbis; beginning of Section I, © istockphoto spx Chrome; Section III, © istockphoto Jacob Wackerhausen. Illustrations are based on author's original whiteboard drawings; remaining photographs belong to the author.

ASA-LESS-PLN2-PD

ISBN 978-1-61954-493-2

Arlynn McMahon began her love of aviation as a youngster. She soloed on her 16th birthday; since that time her feet have rarely been on the ground. Arlynn is a graduate of Aero-Tech of Lexington, Kentucky, and also a graduate of Embry-Riddle Aeronautical University.

Arlynn has helped more than 1,000 students and CFIs fulfill their dreams of flight since she joined Aero-Tech as an instructor in 1984. A career flight instructor, she recently completed a MBA in Strategic Leadership from Amberton University. Today she serves as Aero-Tech's Vice President and Training Centers Manager, responsible for all pilot training and flight activities. She is an active FAA Accident Prevention Counselor and was the 1991 FAA Regional Flight Instructor of the Year and the 2009 FAA National Flight Instructor of the Year. Arlynn specializes in teaching Aeronautical Decision-Making and Cockpit-Risk Management to the aircraft owner/nonprofessional pilot. She is a guest speaker at many aviation safety seminars and functions.

Arlynn possesses an Airline Transport Pilot certificate with multi-engine privileges and a Commercial Pilot Certificate for single engine privileges. She is a FAA Gold Seal and Master Instructor, with CFI, CFII, MEI, AGI, and over 10,000 accident-free hours, including 7,000 hours dual given. She is a Designated Sport Pilot Examiner and a FAAST Representative.

In 2006 Arlynn married her flight instructor and best friend, Charlie Monette. When not in a cockpit, they share sailing, scuba diving and all types of fun in the sun.

Contents

Foreword, by Frank Ayers, Ed.D.	vii
--------------------------------------	-----

SECTION I

EFFECTIVE LESSON PLANS FOR FLIGHT INSTRUCTORS

CHAPTER 1 • Effective Flight Training	3
Lesson Plans versus Maneuver Briefings	4
Holistic Flight Training.....	4
What’s In Store	5

CHAPTER 2 • Common Elements of the Maneuver Briefings	7
--	----------

Whiteboard Drawing	7
Suggested Materials	7
Lesson Introduction.....	7
Components of the Maneuver.....	8
Common Errors versus Keys to Success	8
The 10-20-30 Rule	8
Minimum Acceptable Tolerances During FAA Practical Exams	9
Additional Teaching Tips and/or Scenarios.....	10
Fill-in-the-Blanks Template for Your Airplane	10

CHAPTER 3 • How to Use the Maneuver Briefings	11
--	-----------

Main Points	11
Further Notes on Briefings.....	11

SECTION II

MANEUVER BRIEFINGS WITH A SCENARIO FOCUS

CHAPTER 4 • Airport Operations	15
Traffic Patterns	16

CHAPTER 5 • Takeoffs, Landings and Go-Arounds	23
Normal and Crosswind Takeoff and Climb.....	24
Normal and Crosswind Approach and Landing.....	32
Soft-Field Takeoff and Climb.....	40
Soft-Field Landing	46
Short-Field Takeoff and Maximum Performance Climb.....	52
Short-Field Approach and Landing.....	58
Forward Slips to Landing.....	64
Go-Around or Rejected Landing.....	70
Power-Off 180° Accuracy Approach and Landing	76

CHAPTER 6 • Performance Maneuvers	83
Steep Turns	84
Steep Spiral.....	90
Chandelles	96
Lazy Eights	102

CHAPTER 7 • Ground Reference Maneuvers	109
Rectangular Course	110
Turns Around a Point.....	116
S-Turns Across a Road	122
Eights on Pylons	128

CHAPTER 8 • Slow Flight and Stalls	135
Maneuvering During Slow Flight	136
Power-Off Stalls	142
Power-On Stalls.....	148

CHAPTER 9 • Emergency Operations	153
Emergency Descent.....	154
Emergency Approach and Landing	160

SECTION III
HOW TO USE ANY GENERIC, COMMERCIALY AVAILABLE SYLLABUS
FOR SCENARIO-BASED TRAINING

CHAPTER 10 • The Generic Syllabus With Extras	169
Adding a Scenario.....	169
Using SRM.....	171
The Plan of Action	171

CHAPTER 11 • SRM Templates	173
-----------------------------------	------------

APPENDIX	
Risk Management Preflight Checklist	187

Foreword

Those of us from the FAA, Embry Riddle Aeronautical University, and the University of North Dakota who began the journey toward Scenario Based Training (SBT), Single-Pilot Resource Management (SRM), and Learner Centered Grading (LCG) back in the fall of 2003 knew that others would need to carry the work forward. Arlynn McMahon, 2009 FAA Flight Instructor of the Year, is one of those people. She was with the FAA Industry Training Standards (FITS) program from the early days and has continued to be a strong voice for realistic flight training. To your immediate benefit, Arlynn is also a delightful writer who makes the difficult easy to understand, and takes joy in the art and science of flight instruction.

As with her earlier book, *Train Like You Fly*, Arlynn has taken the fairly complex subject of maneuvers training within the Scenario Based Training methodology, and made it clear and understandable for the working flight instructor. Scenarios add context to the learning of a series of maneuvers. When the student understands meaning before tackling detail, they learn more quickly and more completely. Arlynn seamlessly combines the “why” with the “how” of learning maneuvers.

A soft-field takeoff, S-turns across a road, steep turns, and slow flight can simply be mindless maneuvers learned by rote — or part of a realistic mountain search-and-rescue scenario. The latter provides a vivid context within which the student can understand why it is important to be good at these tasks beyond basic stick-and-rudder skills. Additionally, the instructor can continually help the student make real-time safety and operational decisions during the scenario.

I would especially draw your attention to Section III of *Lesson Plans to Train Like You Fly*, where Arlynn tells us how to apply the principles of Scenario Based Training and Single-Pilot Resource Management to generic flight syllabi. Giving the student a realistic mission, and then guiding them through the detailed preparation and in-flight decision-making associated with the mission, builds repeatable problem solving skills and teaches sound judgment. The subject of “teaching judgment” often causes some disagreement among flight instructors. However, if learning can be defined as the change of behavior in response to stimuli over time, then following the scenario guidance Arlynn details in this text

can surely have a positive impact on student decision-making behavior. Accident statistics consistently remind all of us who flight instruct that this is a critically important goal.

In *Lesson Plans*, Arlynn successfully bridges the gap between the theoretical and the practical. In the “real world” most instructors spend more time in front of a whiteboard than at a computer monitor. Making instruction simple, clear, and easy to repeat provides the instructor with more tools for their teaching bag-of-tricks. This excellent text adds a very valuable tool to that bag. I plan to add it to my flight bag, and I hope you will as well.

Frank Ayers, Ed.D.
Executive Vice President
Embry Riddle Aeronautical University, Prescott
CFI, ATP, B757-767

SECTION I

EFFECTIVE LESSON PLANS FOR FLIGHT INSTRUCTORS



EFFECTIVE FLIGHT TRAINING

CHAPTER I

Congratulations on your decision to become an effective aviation instructor! As an effective instructor you will be expected to teach specific maneuvers and you will be asked to teach people who have never left the bounds of Mother Earth to make decisions while being totally outside of their natural environment. It's a big job.

Watch an Olympic ice skater perform on television and you know they had to learn specific jumps and spins to demonstrate the mastery of their sport. The same is true of pilots. A handful of maneuvers and skills are required to demonstrate proficiency and to pass the test. Just as that Olympic ice skater blends the required jumps into a pleasing routine that flows with grace and elegance, a pilot must combine maneuvers on every routine flight. But whereas an ice skater performs in a confined area and in a controlled environment, pilots are free to fly anywhere, in an endless variety of environments. Most flights are not routine. Some contain the unexpected and pilots often find the need for something never before practiced.

Flying is a thinking sport. It doesn't require great physical strength as other sports do. More like a game of chess, flying requires a pilot to understand how each decision and each move affects the successful outcome.

Most pilot training courses place little or no emphasis on attaining thinking skills. As a result, when a newly trained pilot flies into a new environment or experiences a flight outside of their normal routine, that pilot is sometimes unprepared to make smart decisions.

When all is said and done, flying and teaching flying have more to do with people than they have to do with airplanes.



Lesson Plans versus Maneuver Briefings

This book presents lesson plans for flight instructors in the form of scenario-based “maneuver briefings.”

A lesson plan is an organized outline for a single instructional period. It tells the instructor which teaching method is to be used for the lesson, what is to be taught, and in what sequence to present information. However, often the syllabus calls for a lesson plan to include more than one maneuver.

A maneuver briefing, then, is a kind of lesson plan for presenting an *individual* maneuver. Multiple maneuver briefings can be covered in a single syllabus lesson. Every CFI practical exam requires the applicant to demonstrate his or her ability to teach a “preflight lesson on a selected maneuver as the lesson would be taught to a student.” Many times the evaluator will ask for more than one maneuver briefing.

The term “lesson plan” is the traditional term used in industry; however, in this book I use the term “Maneuver Briefing” to convey the presentation of an individual maneuver as outlined in a Task in the *Flight Instructor Practical Test Standards* (PTS).

Holistic Flight Training

Does any student pilot dream of endless hours of touch and go’s? Does any new pilot expect to be corralled into a practice area to master steep turns? I don’t think so. Many student pilots transferring from other schools report how their excitement for flying was beaten out of them with boring, routine, and mindless training. What they expect and what they dream about is going someplace and spending fun and interesting hours as a pilot. This is what scenario-based training brings back to the industry. Think of it as “holistic flight training.” It is holistic because it encourages students to use all of their senses and to think. It persuades a student to stay excited about this marvelous sport through the completion of training and beyond.

By presenting maneuvers in a scenario format, the student is propelled into the *understanding* and *application* levels of learning while still in the classroom during the maneuver briefing. The use of scenario training fosters safe habits that a student will use long after he has become certificated. Students learn not only *what to do* but also *how to think* in the endless variety of situations that maneuvers may be used while flying in the real world. Scenario-based training is not boring. It is not routine and it is not mindless.



What's In Store

Scenario-based training (SBT) has proven itself as a valuable aviation training methodology. But until now it hasn't been described with clarity and in simple terms that a new instructor can feel comfortable using. In Section II you'll find simple to use, scenario-based, maneuver briefings described in such a way that the student will "get it" because you used fun flying stories and scenarios to illustrate important concepts. You may have to role-play a bit...it will be worth it.

Then later in the book, scenario-based training is added to your favorite syllabus (Section III). There is no need to change syllabi in order to add scenario-based training to your current training methodologies.

In addition to being effective tools for active instructors, these lesson plans are helpful to CFI applicants as learning tools and templates for preparing their own materials. Nearly all CFI applicants must provide at least 2 complete lesson plans as part of the initial CFI practical exam.



AIRPORT OPERATIONS

CHAPTER 4

This chapter contains maneuver briefings on the subject of traffic patterns.

AREA OF OPERATION:

Preflight Lesson on a Maneuver to be Performed in Flight

Note: Evaluator shall select at least one maneuver and ask the applicant to present a preflight lesson on the selected maneuver as the lesson would be taught to a student.

OBJECTIVE:

To determine that the applicant exhibits instructional knowledge of the selected maneuver by:

1. Stating the purpose.
2. Giving an accurate, comprehensive oral description, including the elements and common errors.
3. Using instructional aids, as appropriate.
4. Describing the recognition, analysis, and correction of common errors.

Traffic Patterns

Suggested Materials: Whiteboard and markers, POH, A/FD, and AC 90-66.

INTRODUCTION

Spend at least three minutes introducing the maneuver to the student. Describe the situations that are motivation for learning it, as well as the objectives to strive for.

Motivation

The traffic pattern is a standardized rectangle around the runway. It provides an orderly flow of traffic for aircraft arriving, departing and operating in the vicinity of an airport. At the same time, the traffic pattern provides a flow of cockpit tasks the pilot must complete in preparation for takeoff and/or landing.

Objective

In this lesson you learn the correct procedures to arrive at, depart from, or operate around an airport.

TRAFFIC PATTERNS

RESEARCH (A/FD)

- Procedures
- Traffic pattern altitude (TPA)
- Communications
 - ATIS/AWOS/ASOS
 - ATC/CTAF/blind
- Active runway
- Turns - normally left

WIND CORRECTIONS

ENTRY STRATEGIES

SET UP

- ATIS/AWOS
- Checklist
- ATC/CTAF

When you are ready

Base

- Glidepath
- Descent

1/2-1 mile

ENTRY

- @ TPA
- 45° downwind
- <200 KIAS

45° Exit

300' TPA

Exit

Final

- Stabilized
- Possible go-around

COLLISION AVOIDANCE

- ATC clearances/phraseology
- Right-of-way rules 91.113
- Maintain spacing—don't follow behind
- Cockpit management
- Heads up, eyes out

WAKE TURBULENCE

CHALKBOARD TALK

Elements of the Maneuver

First, a look at the universal elements of the maneuver — those elements that are not aircraft-specific.

Pattern leg names:

- downwind
- base
- final
- crosswind

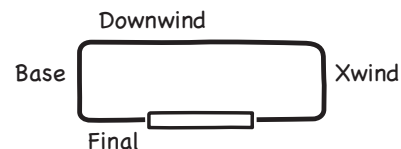

Takeoff begins before leaving the dispatch area. The first thing a pilot does in preparation for takeoff is research:

- ⦿ Research in A/FD,
 - Some airports have special procedures including noise abatement or obstacle clearance.
 - Traffic pattern altitude — what it is, why it's important; in the A/FD, or 1,000 ft AGL.
 - Who will you communicate with — AWOS/ATIS/ASOS (for the latest information about the airport). ATC/CTAF/into the blind (who you might talk to, around the airport).
 - Identify notable obstacles and wires, and the procedures to avoid them.
- ⦿ The active runway should be the one most aligned with wind.
- ⦿ Turns are normally to the left.
- ⦿ Major runway markings and lighting.



Add the cockpit tasks and aircraft configuration changes to complete along each leg:

- \ Set up — about 10 miles outside a nontowered field. At controlled fields it depends on the airspace.
 - Listen to ATIS/AWOS.
 - Aircraft pre-landing checklists.
 - Communicate with ATC/CTAF.
- \ Downwind — primary objective on downwind is to stabilize the airspeed. Starting abeam of the touchdown point,
 - Slow to approach speed and stabilize.
 - Maintain wind corrections to fly and remain parallel to runway.
 - Maintain traffic pattern altitude, don't begin a descent while flying away from the runway.
 - Turn base only when you are ready. If you begin abeam the touchdown point, you should be about 45° (however, this may change).
 - Continue to scan for traffic.
- \ On base — the objective on base is to stabilize the glide path:
 - Reduce power to achieve a speed of about 1.4 V_{SO} .
 - Begin stabilized descent.
 - Continue to scan for traffic.

SET UP
ATIS/AWOS
Checklist
ATC/CTAF

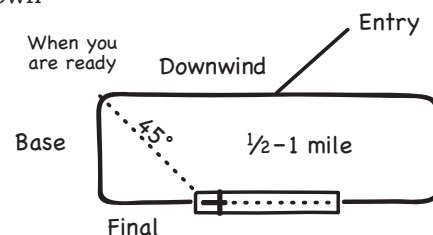

Final — the objective on final approach is to make only small corrections as necessary:

- Reduce power to achieve a speed of about $1.3 V_{S0}$.
- Maintain a stabilized approach speed and glide path.
- Continue to scan for traffic.
- Mentally prepare for possible go-around.

Wind corrections:

- Describe how to correct for wind drift to maintain the proper ground track on each leg.
- Anticipate the turn to final.

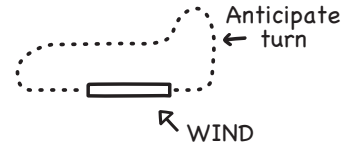

Proper entry:

- Be at traffic pattern altitude before entering traffic pattern.
- On downwind leg, at a 45° angle abeam the midpoint of the runway.
- Less than 200 KIAS.

Discuss entry strategies from different areas around the airport:

- Aircraft/runway diagram showing numbers 1 – 5
- Diagram is not meant to indicate proximity to runway; rather, the general direction they are coming from (due to limited board space).

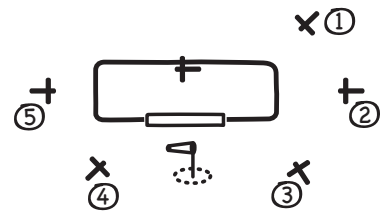

Departing the traffic pattern:

- Straight out.
- 45° left turn off runway heading after reaching traffic pattern altitude.

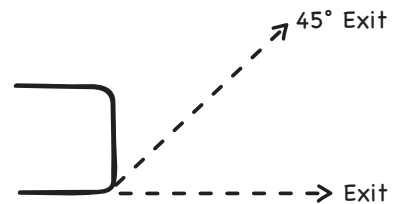

Collision avoidance:

- Controlled fields — ATC clearances,
 - If you accept it, you must comply with it — or have it amended.
 - You don't have to accept it; you are the pilot-in-command.
 - Use proper phraseology.
- Right of Way Rules (14 CFR §91.113) apply — but, if needed for safety, be willing to give up your right of way.
- Maintain proper spacing from other traffic —
 - Slow to approach speed or slower.
 - Widen traffic pattern.
 - Don't follow directly behind another plane. Fly 30° to 45° outside of the other aircraft's traffic pattern.
 - S-turns are not recommended on short/low final.
 - Go-around.
 - Good cockpit management needed to keep your head up and looking around.
- Operations differ at airports without an operating control tower.
- An organized cockpit means less time with your head buried down.

COLLISION AVOIDANCE

- ATC clearances
- Phraseology
- Right-of-way rules
- Maintain spacing
- Cockpit management

Note: Many different types of flying machines use an airport. They affect which method you might need to use to maintain safety around them. Keep your head up and your eyes outside.

Heads up
Eyes out
👁️👁️

Wake turbulence avoidance is an emphasis area for operations in the traffic pattern:

- Explain avoidance in
 - Taking off after larger plane landing.
 - Taking off after larger plane taking off.
 - Landing after larger plane landing.
 - Landing after larger plane taking off.



Performance

Now that the key elements are covered, discuss what will happen in the airplane today. You'll takeoff, fly to a nearby airport, enter the traffic pattern, and land, before returning home. One airport is a pilot-controlled airport (that is, a nontowered one), located in Class G airspace; the other is controlled by ATC in C airspace.

At the pilot-controlled airport:

- About 10 miles out — listen to AWOS; determine the active runway.
- Announce intentions “into the blind” on CTAF at nontowered fields, and listen for other pilots in the area before turning each leg of the traffic pattern.
- Inbound aircraft observe other aircraft already in the traffic pattern and conform to the traffic pattern in use.
- Generally, entry into the traffic pattern will be at a 45° ground track angle to the downwind leg, abeam the mid-point of the landing runway.

At the ATC (tower) controlled airport:

- About 10 miles before entering airspace — listen to ATIS.
- Contact approach control prior to entering terminal airspace, with your intentions. Give them time to work you into the traffic flow.
- Generally, entry into the traffic pattern will be at a 45° ground track angle to the downwind leg, abeam the mid-point of the landing runway (unless otherwise directed by ATC).

Then:

1. Arrive at the appropriate traffic pattern altitude a minimum of two miles from the airport.
 - Traffic pattern altitude — 1,000 feet AGL. Maintain a safe altitude in the traffic pattern considering the possibility of an engine failure; be able to glide to the runway. (Note: The Arrow does not glide well.)
 - Traffic pattern airspeed — reduce speed to about 100 KIAS unless conditions dictate otherwise or until abeam the point of intended landing.
2. About 5 miles from runway, complete the first pre-landing checklist.
3. Correct for wind drift for a tight, close, rectangular pattern, using about ½ to 1 mile distance from runway along downwind, ½ to 1 mile base and ½ to 1 mile final legs.
4. Visually check both left and right before turning to next leg.
5. Avoid traffic collisions, wake turbulence, and wind shear.

On future lessons:

As you continue to develop situational awareness in the traffic pattern, you'll learn how to maintain an awareness of the position of other aircraft in the traffic pattern and the operating considerations of various aircraft types.



Keys for success:

- ✓ Comply with local traffic pattern procedures and Federal Aviation Regulations.
- ✓ Correct for the wind and remain oriented to where you are in relation to the landing area.
- ✓ Maintain adequate spacing for traffic.
- ✓ Maintain a stabilized airspeed and descent path to the runway.

EVALUATION

Minimum Tolerances During FAA Practical Exams

Completion standards for the lesson may vary with the phase of training. For a successful practical test, the applicant must exhibit satisfactory knowledge, risk management, and skills associated with traffic patterns, which include the ability to demonstrate:

1. Properly identify and interpret airport/seaplane base runways, taxiways, markings, and lighting.
2. Comply with proper traffic pattern procedures.
3. Maintain proper spacing from other aircraft.
4. Correct for wind drift to maintain the proper ground track.
5. Maintain orientation with the runway/landing area in use.
6. Maintain traffic pattern altitude, ± 100 feet, and the appropriate airspeed, ± 10 knots.
7. Maintain an awareness of the position of other aircraft in the pattern.

Recommended Training Scenarios:

1. Draw a traffic pattern, labeling the legs and providing a mini-list of cockpit tasks to be completed on different legs.
2. Present a short cross-country using an airport with an operating control tower and an airport without. Compare the differences in traffic patterns at the two airports.

Planning Your Practice

Fill in the blanks for your airplane in the following handy checklist.

Your Traffic Patterns scenario (Make notes here.)

Arriving at _____ Airport

1. Noise abatement procedure _____.
2. Operating at this airport: LSA, gliders, transport, cargo, military, other _____.
3. About _____ miles out:
 - a. Obtain _____ (ATIS/SWOS).
 - b. Determine the active runway.
4. Contact _____ (approach/CTAF).
5. Inbound:
 - a. Observe traffic pattern in use
 - b. Conform to pattern
6. Enter a 45° ground track angle to downwind leg abeam midpoint of landing runway (unless otherwise directed by ATC).
7. Arrive at traffic pattern altitude minimum of _____ miles from the airport:
 - a. TPA _____ AGL or _____ MSL
 - b. Airspeed, reduce to \approx _____ KIAS (unless conditions dictate otherwise)
8. About _____ miles from runway, complete the first pre-landing checklist.
9. Correct for wind drift for close, rectangular pattern:
 - a. Use \approx _____ mile distance from runway along downwind
 - b. _____ miles on base
 - c. _____ mile final legs
10. Visually check left and right before turning to next leg.
11. Announce intentions "into the blind" CTAF on nontowered fields, before turning each leg of the traffic pattern.
12. Avoid traffic collisions, wake turbulence and wind shear.

Downwind

Objective abeam touchdown point—stabilize airspeed.

1. Complete prelanding checklist:
 - a. Below _____ KIAS, select gear down
 - b. Fuel pump _____ (On, Off, N/A, etc.)
 - c. Slowing into white arc _____ flaps
 - d. Cowl flaps _____
 - e. Other _____
 - f. Slow to _____ KIAS, trim, stabilize
2. Scan for traffic.
3. Turn base leg.

On Base

Objective—stabilize the glide path.

1. Reduce power to achieve a speed of about $1.4 V_{50}$ _____ KIAS.
2. Begin stabilized descent.
3. Continue to scan for traffic.

Final

Objective—make only small corrections as necessary.

1. Reduce power to achieve a speed of about $1.3V_{S0}$ _____ KIAS.
2. Maintain a stabilized approach speed and glide path.
3. Continue to scan for traffic.
4. Mentally prepare for possible go-around.

LESSON PLANS TO TRAIN LIKE YOU FLY

Second Edition

Arlynn McMahon

A FLIGHT INSTRUCTOR'S REFERENCE FOR SCENARIO-BASED TRAINING

“When the student understands meaning before tackling detail, they learn more quickly and more completely. Arlynn seamlessly combines the ‘why’ with the ‘how’ of learning maneuvers... [and] provides the instructor with more tools for their teaching bag-of-tricks.”

— from the Foreword by Frank Ayers, Ed.D., Executive Vice President,
Embry-Riddle Aeronautical University

This book presents lesson plans for flight instructors in the form of scenario-based “maneuver briefings.” A rich resource for active instructors, these lesson plans are also helpful to CFI applicants preparing their own materials. *Lesson Plans* can be used as a companion book for flight instructors who are following the principles of scenario-based training taught in Arlynn McMahon’s first book, *Train Like You Fly: A flight instructor’s guide to scenario-based training*.

Lesson Plans is designed to work in complement with any syllabus and the FAA Airman Certification Standards (ACS) and Practical Test Standards (PTS). It explains how to teach each maneuver, making the flight instructor’s favorite syllabus curriculum even more effective and enjoyable for flight students. Each maneuver briefing features a series of drawings instructors can discuss with their students or replicate in the classroom and an accompanying script to teach from, which includes a story or motivation on the why and how the maneuver is applied in actual flight. Common errors are discussed in the form of keys to success, to positively inspire students to become sound aviation citizens.

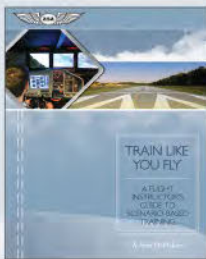

Flight instructor extraordinaire and flight school owner/operator (www.aerotech.net) **Arlynn McMahon** has helped more than 1,000 students and CFIs fulfill their dreams of flight since 1984. She is a nationally recognized, professional aviation educator and leader in the field.

Arlynn McMahon is also author of *Train Like You Fly*. (ASA-TRAIN-FLY)

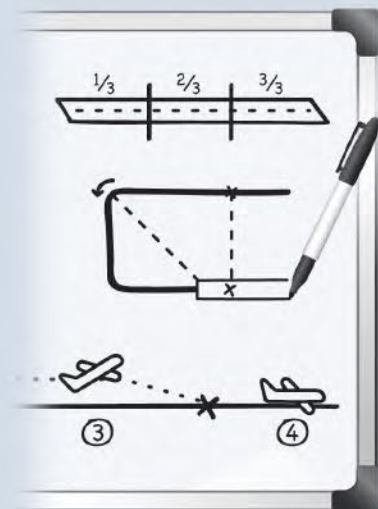

Your maneuver briefings will come alive, with the “what to draw” examples and “what to say” teaching scripts in this book.



Aviation Supplies & Academics, Inc.
7005 132nd Place SE
Newcastle, Washington 98059
www.asa2fly.com • 1-800-ASA-2-FLY
ASA-LESSON-PLAN2