

## AIRCRAFT INSTALLATION MANUAL

### Aircraft & Rotorcraft Products, Incorporated

Model Description: Carburetor Ice Detector Model No.: 107AP FAA STC No.: SA489EA	Revision <b>B</b>	This sheet <b>1</b>	Total Sheets <b>10</b>
--	----------------------	------------------------	---------------------------

#### 1.0 SCOPE

##### 1.1 Purpose

This manual provides the installation and operation instructions needed when using ARP Carburetor Ice Detection Systems Model 107AP.

**WARNING— This instrument is approved as ‘optional’ equipment only and flight operation predicated on its use is prohibited. Instructions provided herein on the use of carburetor heat are intended to supplement existing procedures.**

##### 1.2 Applicability

In accordance with STC SA489EA, ARP Carburetor Ice Detection Systems Model 107AP are approved for installation on normal, utility and acrobatic airplanes and helicopters equipped with Continental, Franklin and Lycoming type engines and Precision Air-Motive (Facet or Marvel-Schebler) MA-2, MA-3, MA-3A, MA-3SPA, MA-4, MA-4SPA, MA-4-5, MA-5, MA-6, MA-6AA and HA-6 series carburetors. The following ARP part numbers are applicable to this manual—

ARP's Carburetor Ice Detection Configurations			
Configuration Type	Part Number	Aircraft Voltage	Pictorial
"Panel Mount"	107AP-12	12V	Photo 1
	107AP-24	24V	Photo 1
"Remote Mount"	107AP-R-12	12V	Photo 2
	107AP-R-24	24V	Photo 2
"Universal Mount"	107AP-U-12	12V	Photo 3
	107AP-U-24	24V	Photo 3
"Probe Assembly"	107AP-P	Both	Photo 4



**Photo 1 – “Panel Mount”**

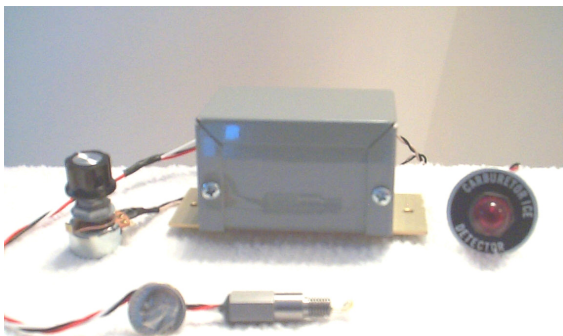

**Photo 2 – “Remote Mount”**

## AIRCRAFT INSTALLATION MANUAL

Aircraft & Rotorcraft Products, Incorporated

Model Description: Carburetor Ice Detector Model No.: 107AP FAA STC No.: SA489EA	Revision <b>B</b>	This sheet <b>2</b>	Total Sheets <b>10</b>
--	----------------------	------------------------	---------------------------



**Photo 3 – “Universal Mount”**

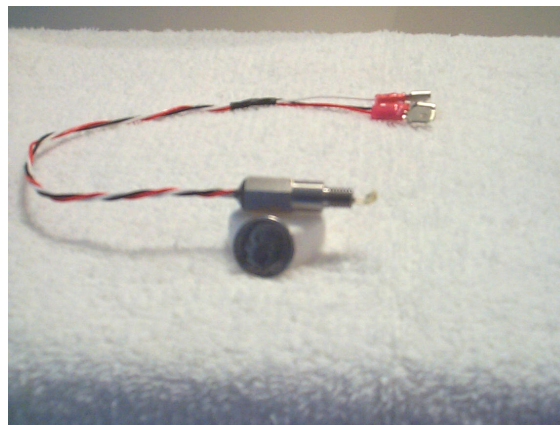

**Photo 4 – “Probe Assembly”**

### 2.0 APPLICABLE DOCUMENTS

PL107AP-INST	ARP Carburetor Ice Detector Installation Kit Parts List
107AP-SUPP	FAA Flight Manual Supplement
STC SA489EA	FAA Supplemental Type Certificate - Carburetor Ice Detector
FAR Part 43	FAA Federal Aviation Regulation - Maintenance, Preventive Maintenance, Rebuilding, and Alterations
AC 43.13-1A	FAA Advisory Circular - Acceptable Methods, Techniques, and Practices – Aircraft Inspection and Repair
AC 43.13-2A	FAA Advisory Circular - Acceptable Methods, Techniques, and Practices – Aircraft Alterations

### 3.0 CONFIGURATION TYPES

“Panel Mount”	Carburetor ice detectors with the red warning light, sensitivity control and on/off switch directly attached to the instrument panel.
“Remote Mount”	Carburetor ice detectors with the sensitivity control and on/off switch directly attached to the instrument panel and the red warning light detached for remote mounting. This warning light is electrically connected to the instrument with discrete wires for installation in virtually any location.
“Universal Mount”	Carburetor ice detectors with the red warning light, sensitivity control and on/off switch detached from the unit’s instrument panel. These devices are electrically connected to the instrument with discrete wires for installation in tight and remote locations.

## AIRCRAFT INSTALLATION MANUAL

### Aircraft & Rotorcraft Products, Incorporated

Model Description: Carburetor Ice Detector Model No.: 107AP FAA STC No.: SA489EA	Revision <b>B</b>	This sheet <b>3</b>	Total Sheets <b>10</b>
--	----------------------	------------------------	---------------------------

#### 4.0 MANUAL CONTENTS

<u>Description</u>	<u>Paragraph Numbers</u>
• General Description	5.0
• Installation Instructions	6.0
• System Operations	7.0

#### 5.0 GENERAL DESCRIPTION

5.1 ARP Carburetor Ice Detection Systems are designed to alert the pilot as to impending engine power loss or stoppage due to ice / frost accumulation inside the carburetor so that carburetor heat can be applied. Unlike temperature sensing devices, this carburetor ice detection system utilizes an electronic light source and feedback sensor. A red warning light inside the cockpit is activated when the probe's radiated light beam and photo-detector sensor, located in the carburetor throat, is blocked due to ice / frost formation. In the absence of carburetor ice / frost the red warning light automatically deactivates

5.2 These carburetor ice detection systems provide real-time detection of ice / frost formation within the carburetor and alerts the pilot accordingly. It is completely independent of temperature or pressure changes which do not affect the system operation except to melt away ice / frost accumulation.

5.3 The rotary sensitivity adjustment control knob is provided to adjust the system sensitivity level for ice / frost detection. This setting should be just above the threshold where the red warning light deactivates and should be set after engine start.

#### 6.0 INSTALLATION INSTRUCTIONS

**IMPORTANT— Read the following instructions completely prior to installation.**

FAR Part 43 requires that methods, techniques, and practices acceptable to the FAA Administrator be used by authorized personnel when altering civil aircraft. Methods, techniques, and practices other than those prescribed in AC 43.13-1A and AC 43.13-2A may be used provided they are acceptable to the FAA Administrator.

##### 6.1 Gaining Access

Remove or open up the engine cowling to allow access to the engine, carburetor and firewall.

##### 6.2 Carburetor Preparation

6.2.1 For carburetors equipped with a factory predrilled and tapped hole remove the existing plug in the carburetor housing just below the throttle (or butterfly) valve and then proceed with paragraph 6.4. (These carburetors have been equipped with a threaded brass plug in a ¼ X 28 tapped hole in lieu of a lead plug filling this access hole.)

6.2.2 If the carburetor is not equipped with a factory predrilled and tapped hole, proceed with paragraph 6.3 for instructions on drilling and tapping a mounting hole in the carburetor barrel prior to proceeding with paragraph 6.4. (Refer to Figures 1 and 2.)

## AIRCRAFT INSTALLATION MANUAL

### Aircraft & Rotorcraft Products, Incorporated

<b>Model Description:</b> Carburetor Ice Detector <b>Model No.:</b> 107AP <b>FAA STC No.:</b> SA489EA	<b>Revision</b> <b>B</b>	<b>This sheet</b> <b>4</b>	<b>Total Sheets</b> <b>10</b>
---	-----------------------------	-------------------------------	----------------------------------

#### 6.3 Drilling and Tapping Carburetor

Adjacent to the butterfly valve in all Precision Air-Motive (Facet or Marvel-Schebler) MA-2, MA-3, MA-4 and MA-4-5 series carburetors is a lead plug filling an access hole through which the idler jets were drilled on the far side of the carburetor barrel. This lead plug fills a stepped hole just below the throttle valve in the aluminum casting. The carburetor wall is approximately 1/4" thick in which this plug is inserted. The instructions prescribed below provides the process for removing the plug, drilling a larger hole and tapping a female thread for mounting the ice detector probe securely at a point adjacent to the butterfly valve. It is at this location the carburetor ice detection system will sense ice / frost accumulation and warn the pilot of impending danger. (Refer to Figures 1, 2 and 3.)

6.3.1 Remove the carburetor assembly from the engine.

6.3.2 Secure the carburetor under a drill press and drill out the lead plug just below the throttle valve using a 7/32" drill bit. Drill slowly and limit the drill travel so that the drill bit does not break through and come in contact with the butterfly valve. (One technique is to apply a bit of putty directly over the inner end of the lead plug to prevent the metal chips from entering the carburetor. If the drill does not pass through the putty the process of removing the metal burrs and chips is simplified.)

6.3.3 Remove all excess lead in order to create a smooth, flat perpendicular surface around the outside of the hole. This will be the mating surface between the carburetor and the ice detector probe.

6.3.4 Tap the hole with a lubricated 1/4 X 28 tap.

6.3.5 Be careful to remove all metal burrs and chips from the interior of the carburetor.

6.3.6 Proceed with paragraph 6.4 for mounting the ice detector probe.

#### 6.4 Mounting Ice Detector Probe

Open the throttle valve wide and carefully screw in the ice detector probe. Exercise caution not to bend or move the probe-sensing component. Install a lock washer and the proper number of shim washers so that when the probe is tightened the indicator marker (red or black dot, or vibra-etched scribed marking) on the probe housing faces in the direction towards the carburetor air inlet. This will position the probe-sensing surface directly into the carburetor air stream. The probe assembly should be tightened by hand as tight as possible and then only 1/4 turn additional using a 3/8" short handle open-end wrench. This is extremely important to prevent over tightening which can over stress the threads. (Refer to Figures 3.)

#### 6.5 Electrical Wiring and System Check

At this time the electrical wiring may be installed to check the operation of the ice detector probe in the carburetor. (Refer to Figures 4 and 5.)

6.5.1 Make certain that a 12-Volt series carburetor ice detector is being installed on a 12-Volt aircraft system, or a 24-Volt series on a 24-Volt system.

6.5.2 Power Cable Installation— Connect the instrument's positive [+] power RED lead wire to the positive [+] side of the aircraft electrical power and the negative [-] ground BLK lead wire to a proper ground on the airframe. Make sure that the RED wire is the power wire from the carburetor ice detector instrument case and not the probe assembly RED wire. Also, in most

## AIRCRAFT INSTALLATION MANUAL

### Aircraft & Rotorcraft Products, Incorporated

<b>Model Description:</b> Carburetor Ice Detector <b>Model No.:</b> 107AP <b>FAA STC No.:</b> SA489EA	<b>Revision</b> <b>B</b>	<b>This sheet</b> <b>5</b>	<b>Total Sheets</b> <b>10</b>
---	-----------------------------	-------------------------------	----------------------------------

aircraft the electrical system is positive [+] with the negative [-] battery post grounded to the airframe. This means the instrument's positive [+] power wire can be connected to the circuit breaker or master switch. On aircraft with positive ground, the power wire must be reversed so that plus meets plus.

6.5.3 System Operational Check— Connect the ice detector probe connectors to the instrument's probe cable connectors. Perform a system operational check described below (refer to Figures 6 and 7 for component setting locations). Make certain that the probe is in a dark area with little or no light on it.

- (a) Turn the instrument's sensitivity adjustment knob to 0 or full counter-clockwise position.
- (b) Set the instrument's on/off power switch to the ON position.
- (c) Slowly turn the sensitivity control up clockwise from 0 to approximately 5 to 8 (or higher).
- (d) The red warning light should turn ON at 0 and turn OFF between 4 and 9.
- (e) If this does not occur check the power supply, wires and connections.
- (f) Be sure the proper color wires from the probe are connected to the same color wires on the instrument.

6.5.4 Disconnect the probe connectors and re-install the carburetor assembly (if previously removed) on the engine with the ice detector probe installed in the carburetor.

6.5.5 Probe Cable Installation— Route the three-wire probe cable from the instrument case through the firewall to the carburetor where the ice detector probe is installed. Reconnect the probe connectors. Replace the fireproof grommet and sealant (as required). Sealant approved for firewalls is Proseal #700 (Coast Proseal Company, Chemical Division), or other approved compound. If a hole does not already exist, drill a 9/16" hole through the firewall, remove all burrs and sharp edges and install a grommet approved for firewalls (i.e. MS35449-2.9 or AN931-2.9). A re-enforcing ring is not required provided the distance from other holes in the firewall is not less than 1 1/2".

6.5.6 Clamp the probe cable with Adel clamps, tie-wraps, or equivalent every 12" to the carburetor, air scoop and engine mount. Be sure to clamp the ice detector probe cable to the carburetor so that there will be no cable movement at the probe due to engine vibration. Allow at least 6" to 8" of slack between the clamping at the carburetor and the engine mount to allow for movement of the engine on the mount.

6.5.7 Tape / insulate the connectors individually to prevent their touching and shorting out, and to seal out dirt and oil.

### 6.6 Mounting Ice Detector Instrument and Components

Refer to AC 43.13-2A Chapter 11 for structural and design considerations when aircraft alterations involve adding or relocating instruments. When making structural changes such as adding holes in the aircraft's instrument panel, refer to AC 43.13-2A Chapter 2, Paragraph 23.

6.6.1 As prescribed in AC 43.13-2A, all instruments shall be mounted in a location easily visible and accessible to the pilot. The carburetor ice detector instrument's red warning light and sensitivity adjustment control should be positioned directly in front of the pilot within reach for adjustment.

6.6.2 Various mounting techniques may be deployed when installing the ice detector instrument. When mounting the instrument case (for "Panel" or "Remote Mount" unit's) in an opening on the aircraft's instrument panel make sure that the opening is suitable for the 2 3/4" x 2 1/8"

## AIRCRAFT INSTALLATION MANUAL

### Aircraft & Rotorcraft Products, Incorporated

<b>Model Description:</b> Carburetor Ice Detector <b>Model No.:</b> 107AP <b>FAA STC No.:</b> SA489EA	<b>Revision</b> <b>B</b>	<b>This sheet</b> <b>6</b>	<b>Total Sheets</b> <b>10</b>
---	-----------------------------	-------------------------------	----------------------------------

enclosure. Secure in-place with four #8-32 (for “Panel Mount” faceplate) or two #6-32 (for “Universal Mount” mounting plate) aluminum round head screws, nuts and lock washers. Self-locking nuts may be used in lieu of standard nuts and lock washers. The rear of the instrument case (for “Panel” or Remote Mount” units) may also be removed and mounted directly to the aircraft’s instrument panel, or small 24ST aluminum brackets may be installed on the sides of the instrument’s rear section in order to mount it in a rectangular cutout in the aircraft’s instrument panel.

- 6.6.3 When installing the red warning light, remove the hex nut (closest to the red lens cover), lock washer and remote lamp faceplate. Insert the threaded lamp holder through the back end of a 1/2” drilled hole in the aircraft’s instrument panel. Peel off the paper strip covering the dry adhesive on the remote lamp faceplate and properly position the faceplate on the aircraft’s instrument panel. Screw nut with lock washer back on and tighten. (Adjusting both nuts may be required to compensate for the thickness of the aircraft’s instrument panel.) Similar technique applies when mounting the sensitivity control and the on/off switch, except the mounting hole for the sensitivity control is 3/8” and 1/4” for the on/off switch.
- 6.6.4 For “Universal Mount” Carburetor-Ice Detectors, P/N’s 107AP-U-12 and 107AP-U-24, affix the Limitation placard, P/N 107AP-106 (provided with the installation kit and illustrated below) adjacent to the red warning light and in clear view of the pilot.

**LIMITATION: FLIGHT NOT TO  
BE PREDICATED ON USE OF  
CARBURETOR ICE DETECTOR**

- 6.6.5 Your ARP Carburetor Ice Detector is ready for operation.

## 7.0 SYSTEM OPERATIONS

Prior to operating an aircraft with ARP carburetor ice detection system, the ice / frost detection sensitivity threshold level needs to be adjusted just above where the red warning light deactivates. Refer to the FAA Flight Manual Supplement.

### 7.1 Sensitivity Setting

After turning the aircraft master switch to the ON position and starting the aircraft engine, set the carburetor ice detector power switch to ON, and rotate the sensitivity adjustment control knob to zero or full counter-clockwise position. The red warning light will turn ON. Slowly rotate the sensitivity control knob up or clockwise until the red warning light turns OFF. This is the threshold setting for ice / frost detection.

Note: After engine start, increase power to run-up setting, and apply carburetor heat for at least 30 seconds prior to adjusting the sensitivity adjustment control knob, to ensure that no ice / frost is present when adjustment is made. Every time a readjustment of the sensitivity adjustment control is required, carburetor heat must be applied for at least 30 seconds, prior to such adjustment, to ensure that no ice / frost is present in the carburetor.

### 7.2 In-Flight Operation

- 7.2.1 After the sensitivity threshold setting has been established, be sure the carburetor ice detector switch is ON and remains ON at all times during flight.

## AIRCRAFT INSTALLATION MANUAL

### Aircraft & Rotorcraft Products, Incorporated

Model Description: Carburetor Ice Detector Model No.: 107AP FAA STC No.: SA489EA	Revision <b>B</b>	This sheet <b>7</b>	Total Sheets <b>10</b>
--	----------------------	------------------------	---------------------------

7.2.2 If the red warning light turns ON, indicating initial ice / frost formation on the probe within the carburetor throat, immediately apply carburetor heat (to both engines if a twin engine aircraft) until the red warning light turns OFF automatically. This indicates the ice / frost has been cleared within the carburetor.

7.2.3 If the red warning light does not turn OFF after approximately two minutes of heat application, the cause may either be an improper sensitivity setting or carburetor icing conditions. Continue flight operation using Flight Manual Procedures and check the carburetor ice detector sensitivity setting after landing.

Note: If the sensitivity setting is improperly set too low, increasing or rotating clockwise the sensitivity adjustment control knob slightly more above the threshold level can correct it.

### 7.3 System Test

To test the carburetor ice detector system, turn the instrument's power switch OFF then ON during normal operation. The red warning light will go ON then OFF indicating that all components are operating properly. (Cycling the power switch OFF and ON simulates ice / frost on the probe.)

### 7.4 Normal Maintenance

7.4.1 With increasing time of operation on the engine (or twin engines) a slight film of fuel residue may form on the probe, which may result in a slight reduction of sensitivity as compared to the original setting when the ice detector is first installed. This will be observed when it is required to turn the sensitivity adjustment knob to an ever increasing clockwise or higher setting as time goes on. However, the basic ice detection sensitivity is not reduced when adjusted as prescribed in paragraph 7.1.

7.4.2 In the event the sensitivity adjustment control must be turned to the full clockwise position and the red warning light does not deactivate, then the probe must be removed and cleaned with a soft cloth (preferably a cotton swab) and white gasoline. Exercise caution not to bend or move the probe's photo-detecting sensing component. Once cleaned, reinstall the probe assembly and check out the system using the instructions prescribed in this manual.

-END-

---

Proprietary rights of Aircraft & Rotorcraft Products, Inc. are included in the information disclosed herein. This document shall not be reproduced or transferred to other documents or used or disclosed to others for manufacturing or for any purpose except as specifically authorized in writing by Aircraft & Rotorcraft Products, Inc.

---

Prepared / Approved: H.P. Rask

Document No. 107AP-INST, Revision: B

Date: 31-January-02

---

File Name: 107ap-inst\_rev\_b.doc

## AIRCRAFT INSTALLATION MANUAL

Aircraft & Rotorcraft Products, Incorporated

Model Description: Carburetor Ice Detector Model No.: 107AP FAA STC No.: SA489EA	Revision <b>B</b>	This sheet <b>8</b>	Total Sheets <b>10</b>
--	----------------------	------------------------	---------------------------

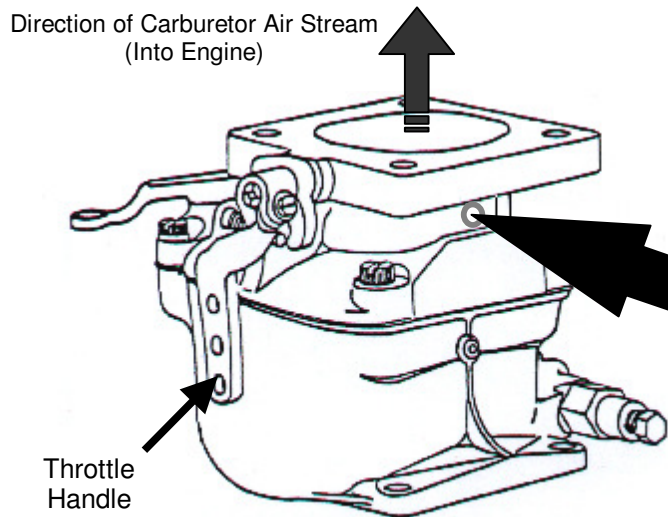

**Figure 1**  
Model MA-2, MA-3 and MA-4

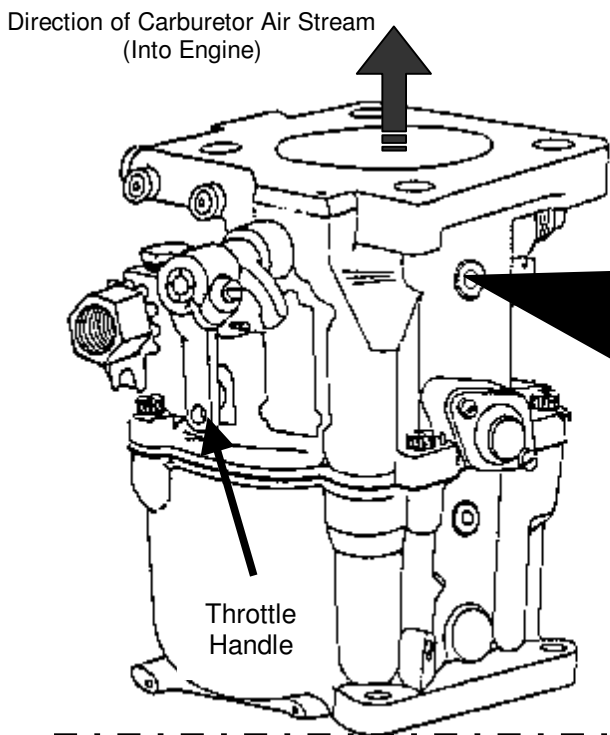
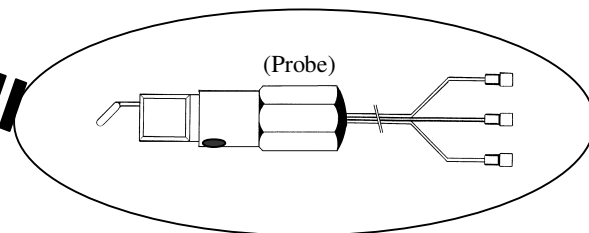

**Figure 2**  
Model MA-4-5

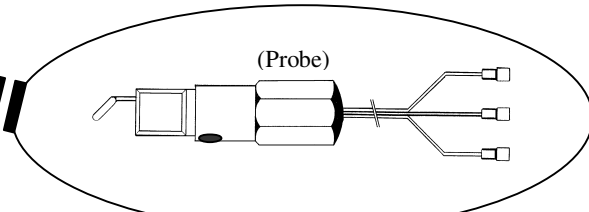

**Note:** Install proper number of shims to ensure black or red dot, or vibra-etched marking on probe housing faces towards the carburetor air inlet.

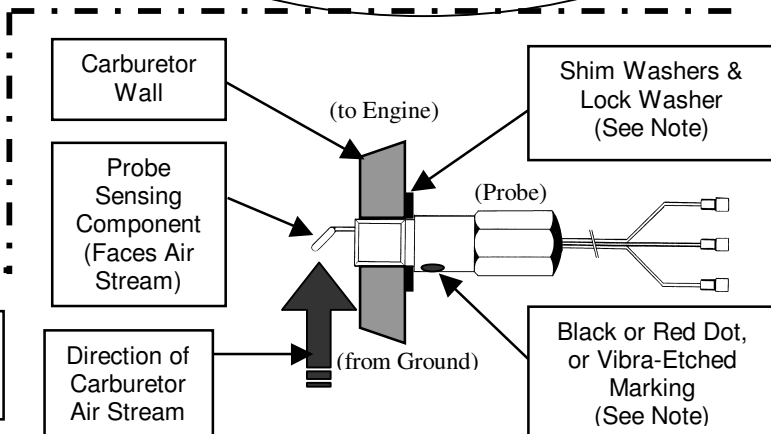

**Figure 3**  
Detailed Side View  
Probe Mounted in Carburetor Wall



## AIRCRAFT INSTALLATION MANUAL

Aircraft & Rotorcraft Products, Incorporated

Model Description: Carburetor Ice Detector Model No.: 107AP FAA STC No.: SA489EA	Revision <b>B</b>	This sheet <b>9</b>	Total Sheets <b>10</b>
--	----------------------	------------------------	---------------------------

**Figure 4**

Ice Detector Instrument

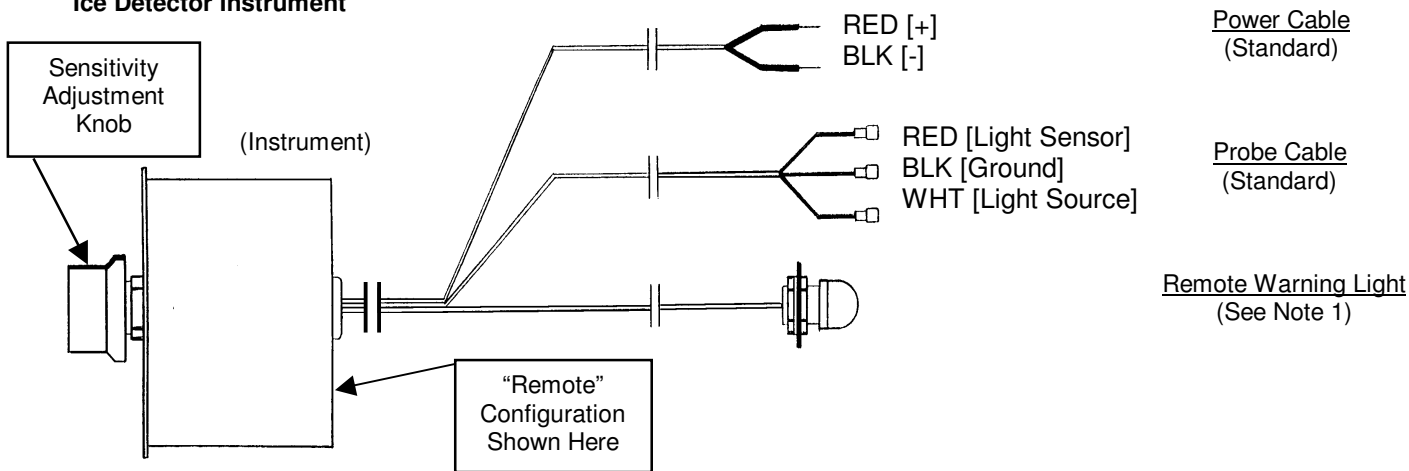

Notes: (1) Remote warning light shown is part of "Remote" configuration unit.

**Figure 5 (Standard Equipment)**

Ice Detector Probe

RED [Light Sensor]  
BLK [Ground]  
WHT [Light Source]

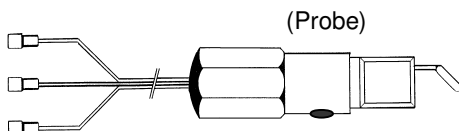

**Figure 6 (Front View)**

"Remote Mount" Configuration

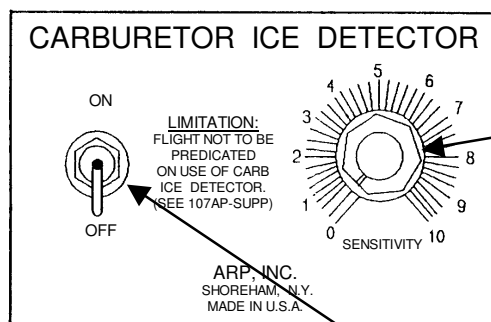

**Figure 7 (Front View)**

"Panel Mount" Configuration

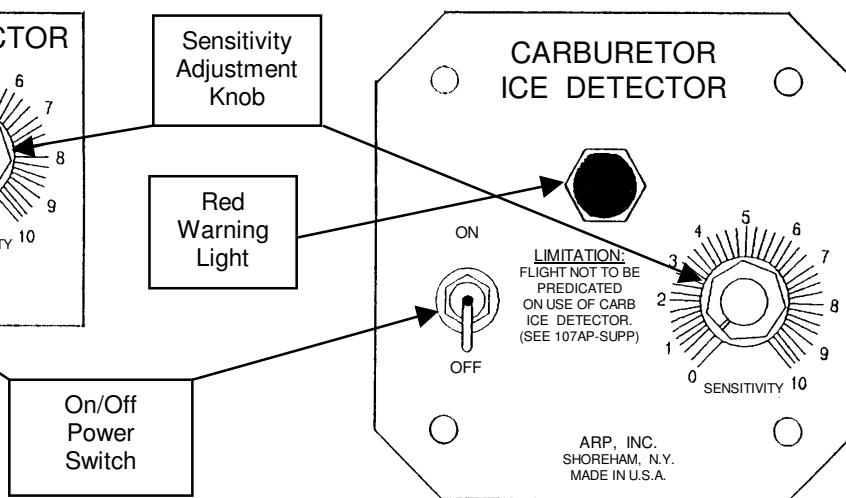

Notes: (2) For "Universal Mount" configuration, the components are the same except they are detached from the unit's instrument panel.

## AIRCRAFT INSTALLATION MANUAL

Aircraft &amp; Rotorcraft Products, Incorporated

Model Description: Carburetor Ice Detector Model No.: 107AP FAA STC No.: SA489EA	Revision <b>B</b>	This sheet <b>10</b>	Total Sheets <b>10</b>
--	----------------------	-------------------------	---------------------------

This document is intended to be used by the aircraft or rotorcraft owner / operator, or an authorized representative, for the installation and / or operation of an ARP product. If the user of this document finds an error or feels that improvements can be made, ARP would appreciate your input. Please fill out this form and forward it via:

- Mail— ARP Inc., 2 Middle Cross Road, Shoreham, N.Y. 11786-1440
- FAX— (631) 821-7933 or Phone— (631) 744-1893
- E-Mail— [arpind@aol.com](mailto:arpind@aol.com)

Document No. \_\_\_\_\_ Rev. \_\_\_\_\_ Section/Page \_\_\_\_\_

**IMPROVEMENT TYPE—**

- Documentation error (format, punctuation, spelling)
- Content error
- Enhancement or refinement

**DESCRIPTION OF IMPROVEMENT—**

---

---

---

**PROPOSED CHANGE** (attach marked-up text or proposed rewrite)—

---

---

---

Please feel free to provide any general comments that might improve future revisions of this document. Thank you.

### WARRANTY INFORMATION

Name: \_\_\_\_\_ Phone No.: \_\_\_\_\_

Address: \_\_\_\_\_ FAX No.: \_\_\_\_\_

\_\_\_\_\_ E-Mail No.: \_\_\_\_\_

Aircraft, Make: \_\_\_\_\_ Model: \_\_\_\_\_ Year: \_\_\_\_\_

Registration No.: \_\_\_\_\_ Serial No.: \_\_\_\_\_

Remarks / Sugestions: \_\_\_\_\_

**OWNER/OPERATOR**— Please complete warranty information and return to ARP, Inc. Thank You.